



MATRIX 4

FLOODLIGHTS AND PROJECTORS



MATRIX 4



Introduction

Square surface architectural floodlight series, adopt isolate structure to fully ensure the stability and long lifespan of LED light. With multi-way rotate function of round support, spike, pole or tree mounting are available to meet various occasions demands for outdoor projects.

Features

- High pressure die-casting aluminum housing.
- High strength toughened glass.
- Surface finish with fluorine carbon spraying ensuring high corrosion resistance, resist the impact and friction.
- LED module: high-power LEDs on metal-core PCB.
- High-efficiency PMMA lens with various beam angle option.
- Zoomable beam angle function option with photoelectron zoom technology.
- Adopt American CREE original LED light source, high flux output, excellent consistency of color.
- Constant current AC100-240, driver with On/Off, DALI, 0-10V control method or DC24V, DC36V input voltage with DMX512, RDM control method.
- Single color with various temperature option: 2700K/3000K/4000K/5000K/6000K.
- Dynamic color with RGBW option have gray level reach 65,536 degree equally make the light result is more beautiful.
- Powerful DMX512 interface adopt high reliable bus connect, all has the function of automatic addressing.

Applications areas

- Facade of outdoor buildings, billboards, sculptures etc.

Mounting type

- Surface mounting, spike, pole, tree mounting etc.

Approvals and markings



Feature



Beam angle

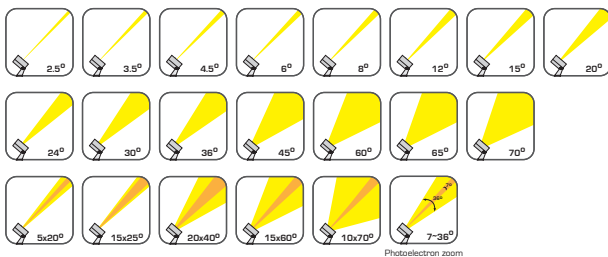

Color temperature

- | | |
|---------------|----------------|
| Single | Dynamic |
| • 2700K | • RGBW |
| • 3000K | |
| • 4000K | |
| • 5000K | |
| • 6000K | |

Product colour



Dimension (mm):

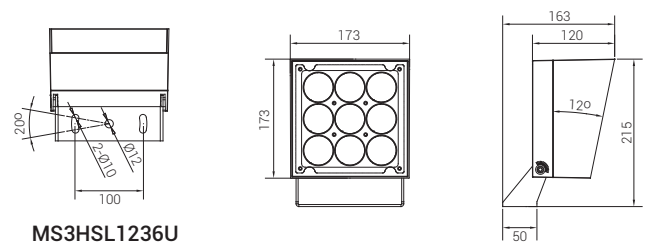

MS3HSL1236U (u-shaped bracket)



We reserve the right to make technical and design changes.

Date: 12-03-2021

THIEN MINH MECHANICAL - ELECTRIC JSC

Head office: MESTAR Building, No. 98/11 Ung Van Khiem Street, Ward 25, Binh Thanh District, Ho Chi Minh City, Vietnam.

Tel: (84) 28.3899 4790 - Email: mestar@mestar.vn - Web: www.mestar.vn

Ha Noi Office: TT4.18, Xuan Phuong Tasco Urban Area, Xuan Phuong Ward, Nam Tu Liem District, Hanoi City, Vietnam.

Tel: (84) 24.3222 2411



MATRIX 4

Variants



MS3HMX1236F
(Flange base)

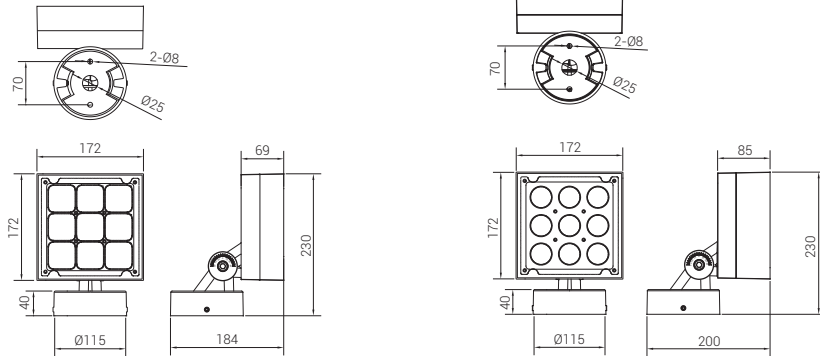

MS3HMX1236S
(Ground spike)

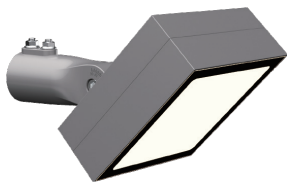
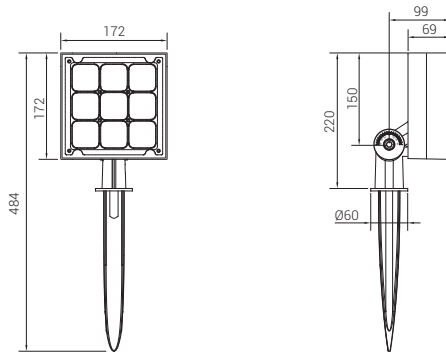

MS3HMX1236M
(Ø48-pole mounting part)

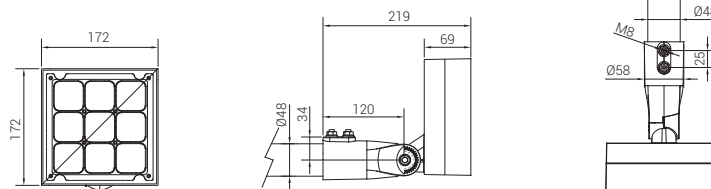

MS3HMX1236L
(pole mounted screw fixed part)

AVL Dia of pole (67-325)mm T≥4

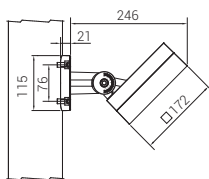

MS3HMX1236H
(tree bracket)

AVL Dia of pole (168-268)mm

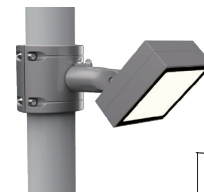
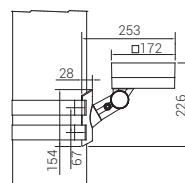

MS3HMX1236Z
(Pole mounted hoop)

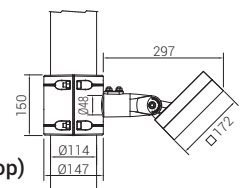

MATRIX 4

Specification

Model	MS3HMX1236FE-45W/60W	MS3HMX1236FF-60W	MS3HMX1236FL-60W
Led brand	CREE/OSRAM	CREE RGBW 4in1	OSRAM
Led quantity	9pcs	9pcs	9pcs
Rated power	45W/60W (Only U type)	60W	60W
Lumen	2925lm/3900lm (±10%)	2400lm (±10%)	2400lm (±10%)
Input voltage	AC100-264V	DC36V/AC100-305V	DC36V/AC100-305V
Frequency range	50/60Hz	50/60Hz	50/60Hz
Color temperature	Single	RGBW	RGBW
Beam angle	2.5° 4.5° 8° 12° 20° 30° 45° 60° 10x70° 5x20°	8° 15° 20° 30° 15x60°	3.5°
Control method	On/Off, DALi, 0-10V	DMX512, RDM	DMX512, RDM
Protection grade	IP66	IP66	IP66
Ambient temperature	-25°C~50°C	-25°C~50°C	-25°C~50°C
Ambient humidity	10%~90%	10%~90%	10%~90%
Product life	50000H	50000H	50000H

Model	MS3HMX1236FC-45W/60W	MS3HMX1236FB-36W	MS3HMX1236FZ-40W	MS3CMX1236F-45W
Led brand	LUMILEDS/OSRAM	LUMILEDS/OSRAM	CREE	CREE COB
Led quantity	18pcs	18pcs	36pcs	1pc
Rated power	45W/60W (Only U type)	36W	40W	45W
Lumen	2925lm/3900lm (±10%)	1440lm (±10%)	2600lm (±10%)	2925lm (±10%)
Input voltage	DC24V/AC100-240V	DC24V/AC100-305V	DC24V/AC100-305V	AC100-305V
Frequency range	50/60Hz	50/60Hz	50/60Hz	50/60Hz
Color	Single	RGBW	Single	Single
Beam angle	6° 15° 20° 30° 45° 20x40° 15x25°	6° 15° 20° 30° 45° 20x40° 15x25°	7 ~ 36° Photoelectron zoom	12° 24° 36° 70°
Control method	On/Off, DALi, 0-10V	DMX512, RDM	Touch screen	DMX512, RDM
Protection grade	IP66	IP66	IP66	IP66
Ambient temperature	-25°C~50°C	-25°C~50°C	-25°C~50°C	-25°C~50°C
Ambient humidity	10%~90%	10%~90%	10%~90%	10%~90%
Product life	50000H	50000H	50000H	50000H

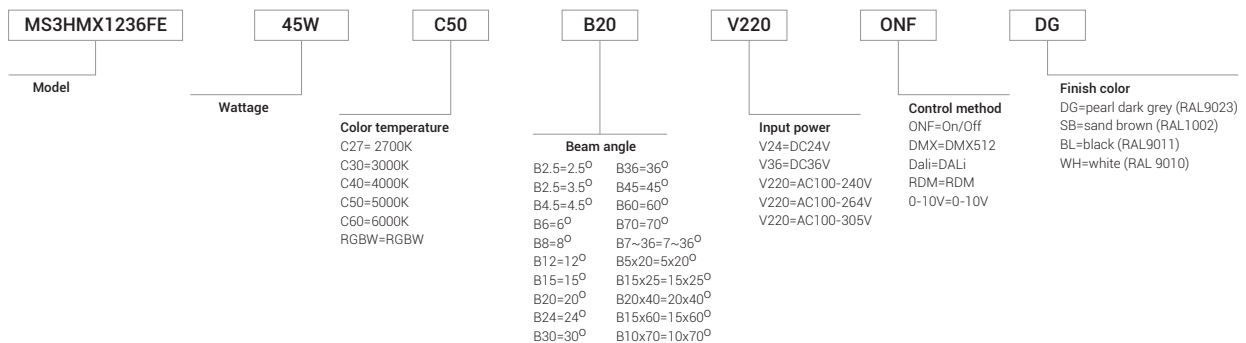
Typical order example

We reserve the right to make technical and design changes.

Date: 12-03-2021

THIEN MINH MECHANICAL - ELECTRIC JSC

Head office: MESTAR Building, No. 98/11 Ung Van Khiem Street, Ward 25, Binh Thanh District, Ho Chi Minh City, Vietnam.

Tel: (84) 28.3899 4790 - Email: mestar@mestar.vn - Web: www.mestar.vn

Ha Noi Office: TT.4.18, Xuan Phuong Tasco Urban Area, Xuan Phuong Ward, Nam Tu Liem District, Hanoi City, Vietnam.

Tel: (84) 24.3222 2411



MATRIX 4

Accessories

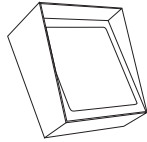

Anti-glare shield
MA-1236-AGS

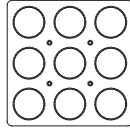

Square-meshed grill
MA-1236-SMG

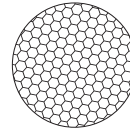

Honeycomb grill
MA-1236-HGR



Honey comb glass
MA-1236-HGL

MS3HMX1236FE-45W/60W	•	•	•	•
MS3HMX1236FF-60W	•	•	•	•
MS3HMX1236FL-60W	•	•	•	•
MS3HMX1236FC-45W/60W	•	•	•	•
MS3HMX1236FB-36W	•	•	•	•
MS3HMX1236FZ36W-40W	•	•	•	•
MS3CMX1236F-45W	•	•	•	•

Connection Accessories



Connector 3 pin - IP68
MA-M684-03



T Connector 3 pin - IP68
MA-M685T-03



Y Connector - IP68
MA-M685Y-03



Junction box 3 holes - IP68
MA-M686-03

